







English

User Manual

**BP-LFP-1025S(D)**



## Legend of used symbols

Symbol	Description
	Attention! Important hazard warning. <i>Attention! Avertissement de danger important.</i>
	Do not dispose of in the domestic waste. <i>Ne pas jeter avec les ordures ménagères.</i>
	Warning of electrical voltage. <i>Avertissement de tension électrique.</i>
	Battery intended for recycling. <i>Batterie destinée au recyclage.</i>

## Revision Directory

Date	Change
07.12.2021 Revision 0-1	Initial version
30.03.2022 Revision 1	Release version
07.11.2022 Revision 1-1	DIN-Rail model included

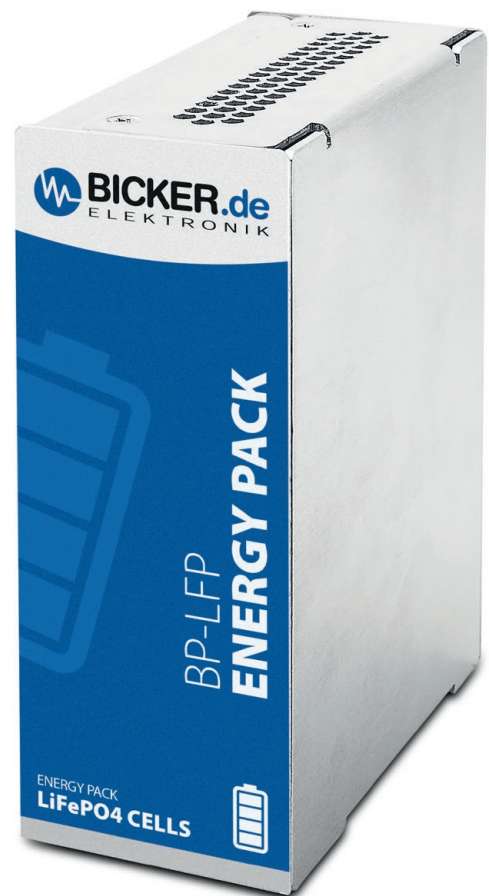

<b>A</b>	<b>Features</b>	<b>5</b>
<b>B</b>	<b>Safety instructions</b>	<b>6</b>
B1	General information	6
B2	Safety warnings for battery use	6
<b>C</b>	<b>Connections of battery system</b>	<b>8</b>
<b>D</b>	<b>Technical data</b>	<b>9</b>
<b>E</b>	<b>Functionality of BMS</b>	<b>13</b>
E1	Protection functions	13
E2	Charging behaviour	14
E3	Balancing	14
E4	Discharge	14
E5	Discharging process	15
E6	Charging process	15
<b>F</b>	<b>Additional functions</b>	<b>15</b>
<b>G</b>	<b>Scope of delivery</b>	<b>16</b>
<b>H</b>	<b>Handling and storage instructions</b>	<b>17</b>
<b>I</b>	<b>Transport instructions</b>	<b>17</b>
<b>J</b>	<b>Disposal instructions</b>	<b>18</b>
<b>K</b>	<b>Other information</b>	<b>18</b>

## A Features

### BP-LFP-1025S(D)

9.9V / 2.5Ah

- ✓ System present function
- ✓ Integrated temperature sensor
- ✓ Very high storage capability
- ✓ Ideal for long backup time
- ✓ 100% lead and cadmium free
- ✓ 5x higher life span than lead-acid batteries
- ✓ UN 38.3 transport certification
- ✓ Safe lithium iron phosphate technology
- ✓ Extended temperature range -20...+55 °C
- ✓ Compact and reliable design
- ✓ IEC 62133-2 approved



BP-LFP-1025S



BP-LFP-1025SD

## B Safety instructions

### B1 General information

**The safety instructions must be read completely before the first time use!**

**In addition, please regard the corresponding data sheet for safety use.**



Incorrect operation or connection may result in serious injury or death. Exaggerating the limits or personal errors may lead to the risk of explosion. When working with the batteries, extra care must be taken that no jewelry such as rings or watches are worn, which can cause a short circuit.

### B2 Safety warnings for battery use



The described limit values of the battery module must be observed. A violation of the limit values can cause excessive heating, a defect in the battery module or fire.

As with other batteries, lithium batteries also have the potential to continue being a source of danger even in the supposedly discharged state, as they can deliver a very high short-circuit current.

Too deep discharge leads to permanent damage. Deeply discharged battery modules may no longer be charged or operated. For example, deep discharge can occur when stored for a long time without operation.

The battery must not be disassembled, opened, damaged or crushed.

The battery should not be exposed to heat or fire. Direct sunlight should be avoided.

The battery should be kept out of the reach of children.

The battery must not be short-circuited or connected with the wrong polarity.

The connection cables and plugs of the battery must not be modified.

One or more batteries should not be stored forcefully in a box or drawer where they could short-circuit each other or get short-circuited by other conductive materials.

The battery must not be subjected to mechanical shocks.

Only use specific chargers designed for use with lithium iron phosphate battery systems.

The polarity symbols plus (+) and minus (-) on the cells or batteries must always be observed. The correct use must be ensured.

The battery should be kept clean and dry.

If the battery connections become dirty, clean them with a dry, clean cloth.

The battery must be charged before use. The instructions of the manufacturer or the information in these instructions for correct charging must always be observed.



**If a cell leaks, the fluid must not come into contact with the skin or enter the eyes or mouth.**

#### **Measures in case of inhalation**

Vapors or mists escaping from a damaged cell can cause respiratory irritation. When inhaling the contents of an open cell, remove the source of contamination or remove the affected person to fresh air. Seek medical help immediately.

#### **Measures in case of eye contact**

Contact with the contents of an opened cell can cause severe chemical burns or eye irritation. If eye contact occurs with the contents of an opened cell, immediately rinse the contaminated eye(s) with a lukewarm, slightly flowing stream of water for at least 30 minutes. Keep eyelids open. Neutral saline may be used as soon as available. If necessary, further rinse the eyes during transport to the emergency supply station. Take care that contaminated water is not flushed to the naked eye or face. Immediately transfer the affected person to an emergency care center.

#### **Measures in case of skin contact**

Contact with the contents of an opened cell can cause chemical burns. If skin contact occurs with the contents of an opened cell, remove contaminated clothing, shoes and leather parts. Rinse immediately with lukewarm, low flow water for at least 30 minutes. Seek medical attention if irritation symptoms or pain persist. Thoroughly wash or dispose of clothing, shoes and leather goods before reuse.

#### **Measures if swallowed**

Contact with the contents of an opened cell can cause severe chemical burns to the mouth, esophagus and gastrointestinal tract. If you swallow the contents of an opened cell, rinse mouth thoroughly with water– except the person becomes unconscious, is unconscious or has seizures. **DO NOT INDUCE VOMITING.** In case of spontaneous vomiting, place the affected person in a forward bent position to reduce the risk of suffocation. Rinse mouth again with water. Immediately transfer the affected person to an emergency care center.

## C Connections of battery system

### POWER SUPPLY

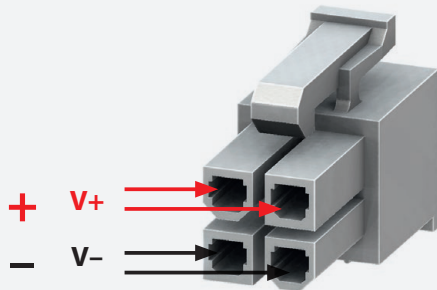

2x Red (Plus): AWG 18

2x Black (Minus): AWG 18

Cable length

BP-LFP-1325S: 345...365 mm

BP-LFP-1325SD: 335...355 mm

Plug: WST (WELI SHENG TERMINAL),  
P/N: P4-I42002

### COMMUNICATION

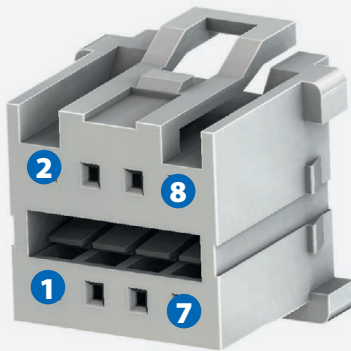

AWG 24

Cable length

BP-LFP-1325S: 345...365 mm

BP-LFP-1325SD: 335...355 mm

Plug: Würth Elektronik,  
P/N: 624008213322

PIN	FUNCTION
1	NTC-Pin 1
2	internal (do not use)
3	NTC-Pin 2
4	internal (do not use)
5	N/A
6	SYSPRES
7	+5 VDC
8	GND



## D Technical data

<b>BP-LFP-1025S(D)</b>	
<b>ELECTRICAL DATA</b>	
Cell type	ANR26650-M1B (Lithium Werks)
Nominal capacity	2.5 Ah
Nominal voltage	9.9 V
Energy	24.75 Wh
Voltage range Corepack	7.5 V – 11.1 V
Overvoltage switch-off	Once first cell reaches 3.7 V
Overvoltage switch-off Recovery	Single cell at 3.5V
Undervoltage switch-off	Once first cell reaches 2.5 V
Undervoltage switch-off Recovery	Single cell at 2.7 V
Fuse	15 A
Own power consumption	State of storage: max. 15 $\mu$ A Activated state: max. 500 $\mu$ A
Maximum installation height	5000 m

<b>CHARGING PARAMETERS</b>	
Recommended end-of-charge voltage	10.35 V $\pm$ 0.15 V
Charging mode	CC/CV
Recommended charging current	1 C (2.5 A)
Maximum charge current	2.4 C (6 A)
Operating temperature range	-20...+55 °C
Shutdown temperature range	On BMS nonexistent. Based on the NTC value, the user must switch off.

<b>DISCHARGE PARAMETERS</b>	
End-of-discharge voltage	~7.5V
Recommended discharge current	2 C (5 A)
Maximum discharge current	5.6 C (14 A)
Operating temperature range	-20 °C...+55 °C
Shutdown temperature range	On BMS nonexistent. Based on the NTC value, the user must switch off.

### TEMPERATURE SENSOR

Type	NTC
Value (at +25 °C)	10 kΩ
B value	B3950
Position	Between two cells (outer wall)

### HUMIDITY

Operating	10...90 % RH, non-condensing
Storage	10...80 % RH, non-condensing

### MECHANICAL DATA BP-LFP-1025S

Length	103 mm (without cable outlet)
Width	68...70 mm
Height	30...32 mm
Weight	0.32 kg

### MECHANICAL DATA BP-LFP-1025SD

Length	120 mm (without cable outlet)
Width	100 mm
Height	45 mm
Weight	0.6 kg

### STORAGE

Recommended temperature range	25 °C ±5 °C
Maximum temperature range	-20 °C...+55 °C
Recommended State of Charge (SOC)	80 %

**MECHANICAL DIMENSIONS**

**BP-LFP-1025S**

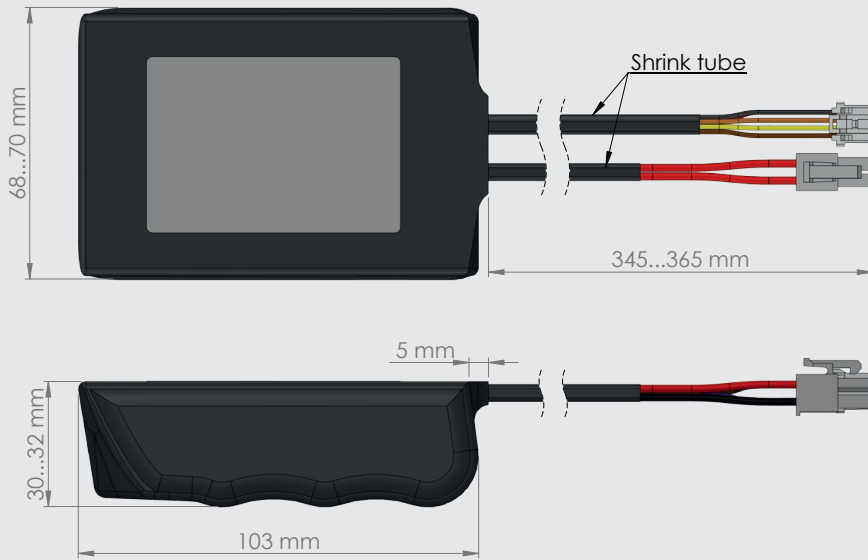

Unless otherwise stated,  
Tolerance according to:  
DIN ISO 2768 T1 - m  
DIN ISO 2768 T2 - K

**BP-LFP-1025SD**

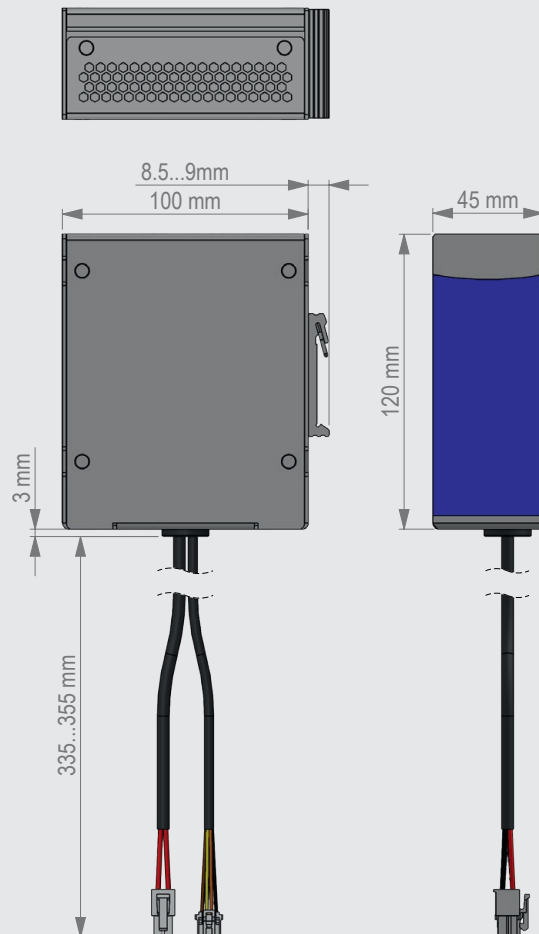

Unless otherwise stated,  
Tolerance according to:  
DIN ISO 2768 T1 - m  
DIN ISO 2768 T2 - K

**Backup time\*** (in use with a UPSI-1208(D))

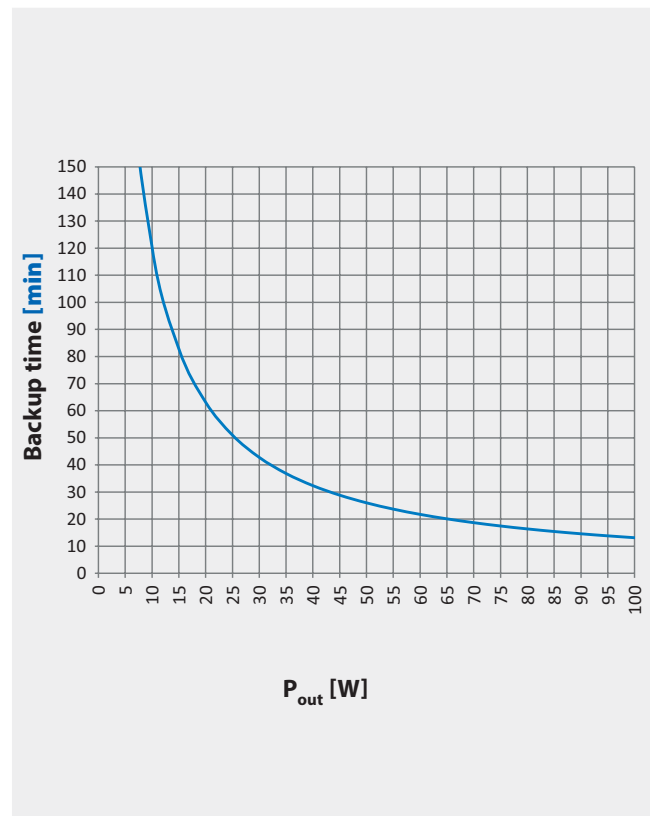
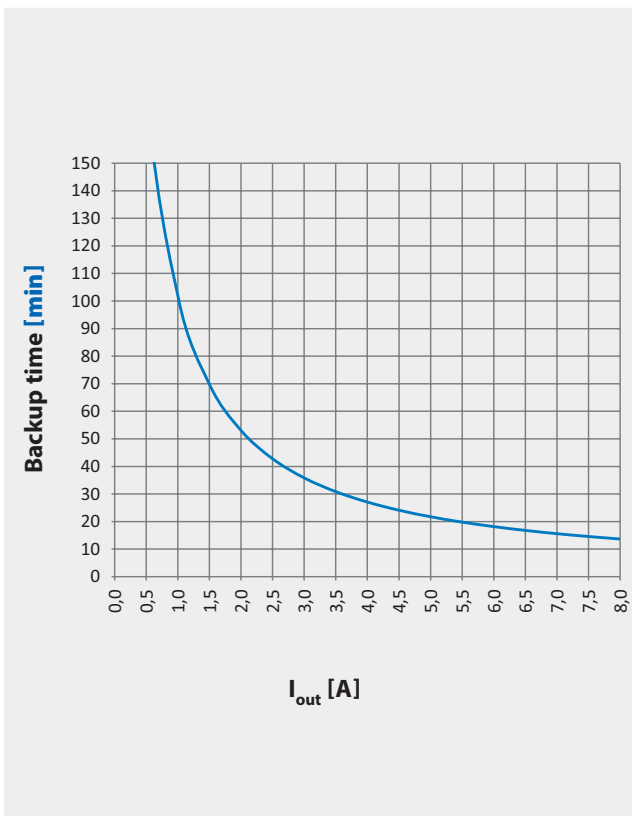
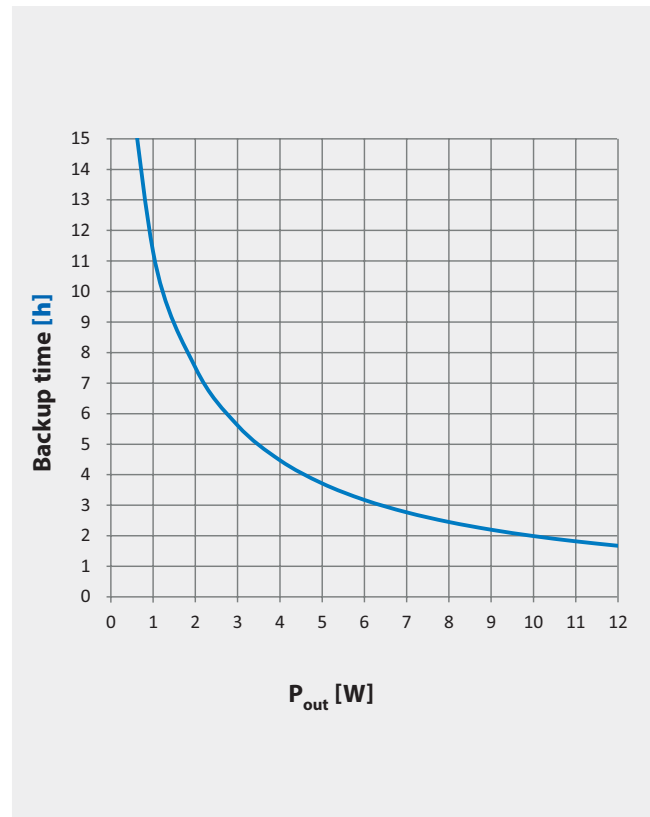
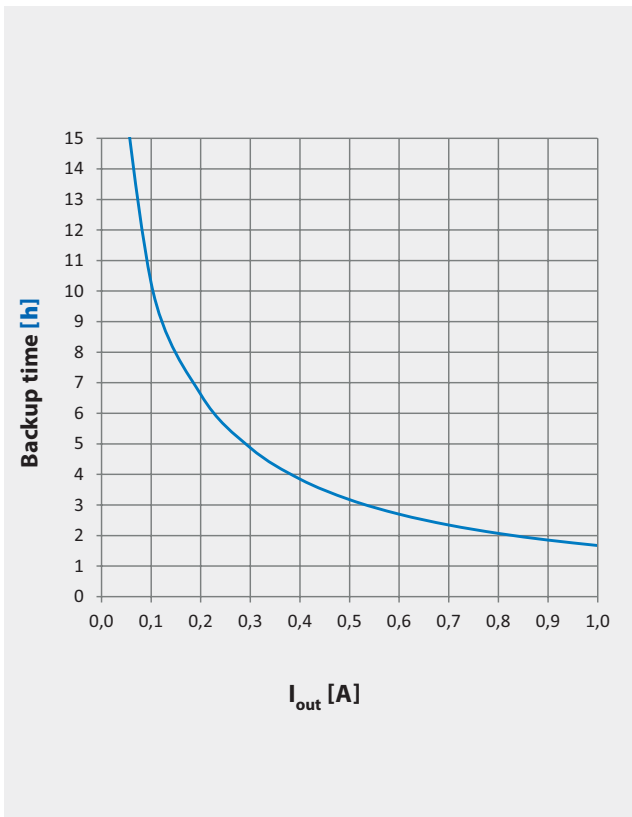

\*Backup time depends on battery capacitance, load and temperature. At very high or low temperatures a reduction of backup time occurs. Unless otherwise specified, the values apply to measurements at +25 °C

APPROVALS	
UL	n.a. (available upon request)
IEC/EN	EC/EN62133-2
UN	UN38.3 transport regulation

## E Functionality of BMS

If the BMS is in ACTIVE MODE, the single cell voltages of the energy storage are monitored continuously by battery management system for compliance with the limits. In the event of a fault, the battery system disconnects the main current path. Charging and discharging is only possible with an activated battery management system.

### E1 Protection functions

The BMS has several possibilities for detecting fault conditions. The following is a basic breakdown into short-term, reversible and permanent errors:

If a short-term, reversible fault occurs during operation (e.g. short-circuit), the electronics will switch off briefly and then switch on again when the fault no longer exists, otherwise the battery will remain deactivated.

If a permanent fault occurs during operation, the battery remains permanently deactivated and can only be re-enabled by the manufacturer (after troubleshooting).

#### Limits for permanent errors:

	Short circuit and overload detection
Switch off (irreversible)	15 A fuse

#### Limits for short-term, reversible errors:

Abbreviation	Description	Limits
CUV	Cell undervoltage detection	2.5 V (Recovery 2.7 V)
COV	Cell overvoltage detection	3.7 V (Recovery 3.5 V)

## E2 Charging behaviour

The charging behaviour depends on the procedure described in chapter 'Charging process'. For this purpose, a suitable charger should be used.

Abbreviation	Description / Condition	Comments
Charge Term Taper Current	Current at end of charge	Limit Current <200 mA
CUV_RECOV_CHG	After discharge, the output voltage remains deactivated until a loading process has taken place.	Function is activated

The charging process is finished when the current has dropped below the value of the Charge Term Taper Current.

### Charging an empty battery system

If a single cell falls below a voltage of 2.5 V, the discharge MOSFETs are blocked to prevent damage to the cells. As soon as a charger is connected and its output voltage is active, the battery gets charged. The pin "System Present" (F „Additional functions") of the communication plug must be switched to GND. If all cell voltages exceed 2.7 V, the battery can be discharged again.

#### Note:

Under extreme conditions e.g. at particularly low or high temperatures, the charging and discharging behaviour in conjunction with your application should be checked. The cell characteristic leads to a different voltage behaviour of the cells.

## E3 Balancing

The BMS balances the cells during and if necessary after charging process. If a single cell voltage of about 3.55 V is exceeded, the affected cell level is automatically balanced.

Description	Limits
Limit balancing	$\geq 3.55$ V single cell voltage
Balancing current	$\sim 130$ mA
Recovery balancing	$\leq 3.50$ V single cell voltage

## E4 Discharge

The BMS switches off the output voltage when the final discharge voltage is reached. Protective functions of temporary, reversible or permanent faults and short-circuit detection are not affected by this!

After complete discharge, charge the battery system soon (within 7 days) to avoid a deep discharge.

## E5 Discharging process

During discharge process, the pack voltage drops from the end-of-charge voltage (100% SOC) to end-of-discharge voltage (0% SOC). Depending on current, the remaining capacity decreases continuously. If the battery management system detects an error, it will be shut down as described in Section 'Functionality of BMS'.

## E6 Charging process

Before using the charger for the first time, it is essential to read the operating instructions for the charger used! Recommended charging unit UPSI-1208(D).

### General information

The charging process takes place according to the CC-CV procedure. After a charging phase with constant current (CC) up to the end-of-charge voltage, the battery is charged with a constant voltage (CV) and sinking current until the end of charge. Once the loading process has been successfully completed, pack-specific parameters (e.g. capacity etc.) are updated and the core pack is considered fully loaded. If the battery management system detects an error, a shutdown occurs as described.

## F Additional functions

### System Present function

The use of this function is mandatory for the use of the battery. To enable the main current path, PIN 6 (SYSPRES) of the communication connector has to be bridged to PIN 8 (GND) or to V- of the power connector (GND). Otherwise, the BMS permanently blocks the main MOSFET switch.

Status PIN	Behaviour battery
Communication connector PIN 6 open load	Main current path locked, charging and discharging of the battery is impossible
Communication connector PIN 6 bridged to PIN 8 (GND) or V- of the power connector (GND)	Main current path unlocked, charging and discharging of the battery possible

### Note:

In case of a failure, the MOSFET main switch is not enabled despite of activated System Present function.

### NTC temperature sensor

The evaluation of the NTC temperature sensor (PIN 1 and 3 of the communication connector) is also mandatory for the use of the battery. The temperature sensor is attached directly to the outer wall of a cell and thus measures the cell temperature directly. The cell temperature must never leave the given limit values, otherwise there is a risk of fire and explosion.

Allowed temperature range for the built-in cell ANR26650-M1B:

Charge: -20°C up to +55°C

Discharge: -20°C up to +55°C

The resistance of the NTC can be measured between PIN 1 and 3 of the communication connector.

Used type: temperature sensor, e.g. TDK B57891M0103K000

Resistance value: 10 k $\Omega$ -NTC

Type: B value 3950

**The corresponding values can be obtained by the manufacturer TDK.**

## G Scope of delivery

QUANTITY	DESCRIPTION
1x device	Energy storage BP-LFP-1025S(D)



## H Handling and storage instructions



The battery has to be protected immediately after the disconnection from UPSI-2406DP1 or the application. No foreign particles (e.g. metal splinters, small nails, chips or other conductive metals) should enter the battery.

The battery should not be exposed to moisture (water, rain water, snow, etc.) during storage.

To avoid deep discharge, the battery should be charged before storing and checked at least every 2 months. If necessary, the battery is to be charged to 80 %.

The battery should be stored in a cool and dry place where it is protected from damage and unauthorized access.

High temperature fluctuations in the storage area should be avoided, for example storage next to heaters. Do not expose battery modules permanently to solar radiation.

To achieve optimum battery life, it should be stored at a temperature of  $+25^{\circ}\text{C} \pm 5^{\circ}\text{C}$  and a humidity of 10 % to 80 %. The state of charge should be more than 30 %, ideally 80 %.

When the battery is completely discharged, the battery must be charged as soon as possible.

## I Transport instructions

The commercial transportation of lithium batteries is subject to the dangerous goods law. Transport preparations and transportation must only be carried out by appropriately trained persons or the process must be accompanied by appropriate experts or qualified companies.



### Transport regulations

Lithium batteries are subject to the following dangerous goods regulations and exceptions – in the respective current version:

- **Class 9**
- **UN 3480: LITHIUM-ION BATTERIES (including lithium-ion polymer batteries)**
- **UN 3481: LITHIUM ION BATTERIES CONTAINED IN EQUIPMENT or LITHIUM ION BATTERIES PACKED WITH EQUIPMENT**
- **Packing group: II**
- **Tunnel category E**

### Transport of damaged or defective battery modules

Defective or damaged battery modules are also subject to the stricter transport special provision SP 376. These reach all the way to packaging in an aluminum box with vermiculite filling or a complete transport ban.

### Air transport of waste batteries

Waste batteries and batteries transported for purposes of recycling or disposal are excluded from air freight unless authorized by the competent national authorities of the country of origin and the country of the executing company. (IATA DGR SP A183)



### Batteries for disposal and recycling (road/railway/sea)

Lithium batteries may be transported for disposal and recycling in accordance with ADR SP 230 and SP 188, as applicable, or, if they have a gross mass of not more than 500 g, according to ADR SP 636 b.

### Transport of used battery modules

When transporting used, intact and undamaged battery modules, the regulations for new batteries can usually be applied.

### Special and packaging regulations

The battery modules have an energy content of less than 100 Wh, therefore simplifying special provisions of the dangerous goods law can be applied:

- **ADR, RID: SP 188;**
- **IMDG: SP 188;**
- **IATA: PI 965, 966, 967, each section II**



For detailed transport instructions please refer to the safety data sheet!

## J Disposal instructions

Used battery modules must be returned at the point of sale or in a special disposal system (industry, trade). The return is free. The battery modules must not be disposed of with household waste and must be collected separately from any further waste. The battery modules must not be allowed to enter sewers or bodies of water or be buried in the ground. The used battery modules must also be treated in accordance with section H (page 16) "Handling and storage instructions". They should preferably be given for disposal in a discharged condition and in a plastic bag or in their original packaging.

## K Other information

The instructions in this operating manual merely provide assistance for compliance with legal requirements, but do not replace them. The information provided has been compiled to the best of our knowledge and belief.

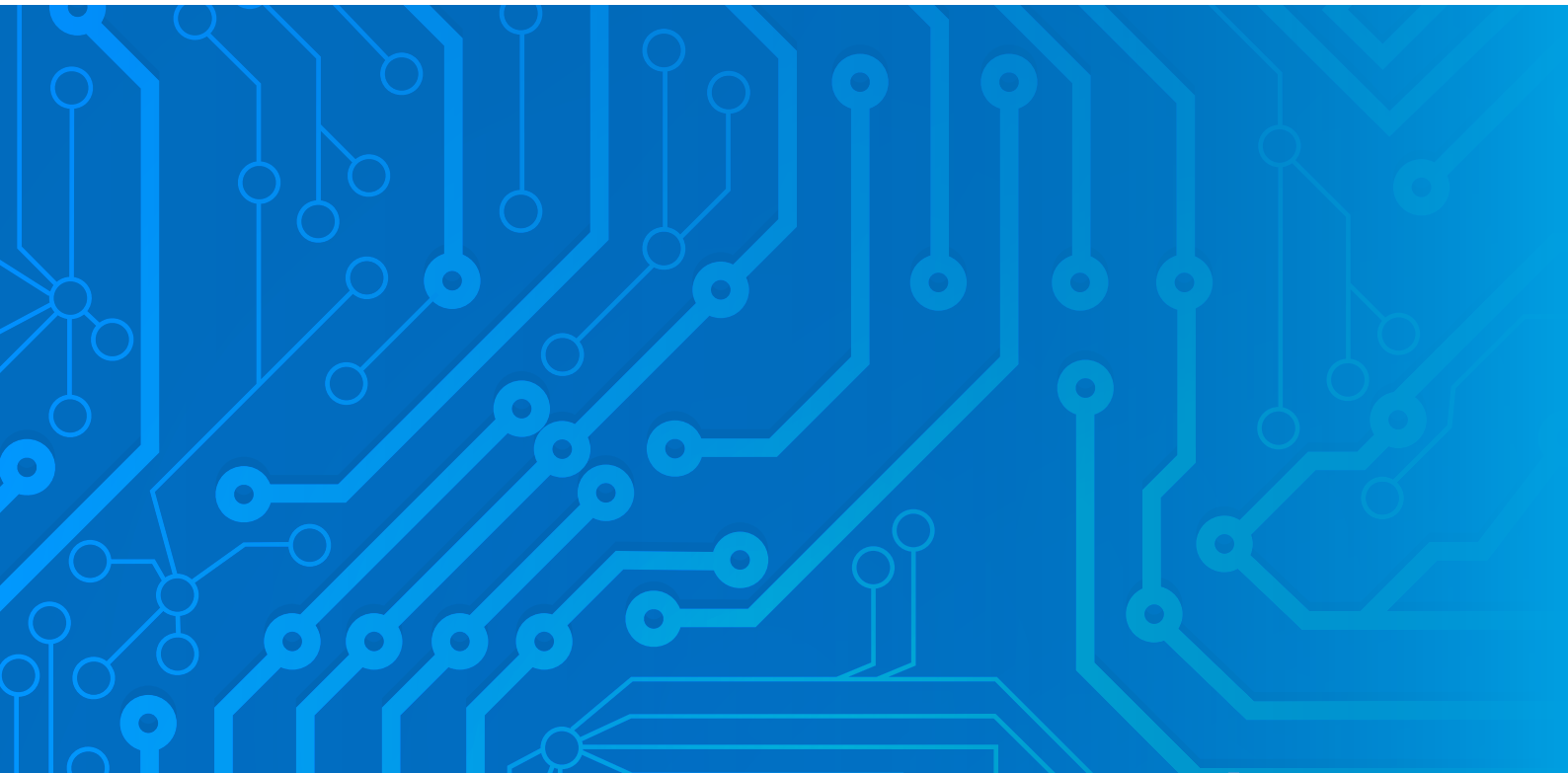

Note: Subject to errors and technical modifications!  
Windows® is a registered trademark of the Microsoft Corp.  
Status as at: 07.11.2022 - Revision 1-1



---

Bicker Elektronik GmbH  
Ludwig-Auer-Straße 23  
86609 Donauwörth · Germany  
Tel. +49 (0) 906 70595-0  
Fax +49 (0) 906 70595-55  
E-Mail [info@bicker.de](mailto:info@bicker.de)  
**[www.bicker.de](http://www.bicker.de)**