

DRAW ID
CD

4

3

2

1

REVISION				
REV.	DESCRIPTION	ECN NO.	DATE	Requirement Person
X0	NEW CREATION		21.07.14	shunhua



醋酸膠布

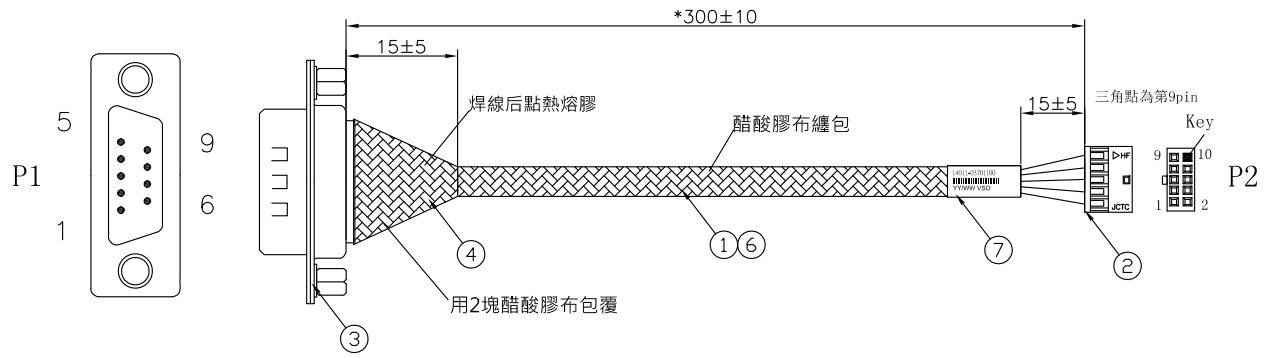

WIRE LIST

P1	P2
1	1 BLACK
2	2 BLACK
3	3 BLACK
4	4 BLACK
5	5 BLACK
6	6 BLACK
7	7 BLACK
8	8 BLACK
9	9 BLACK

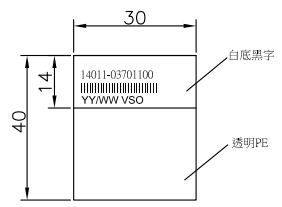
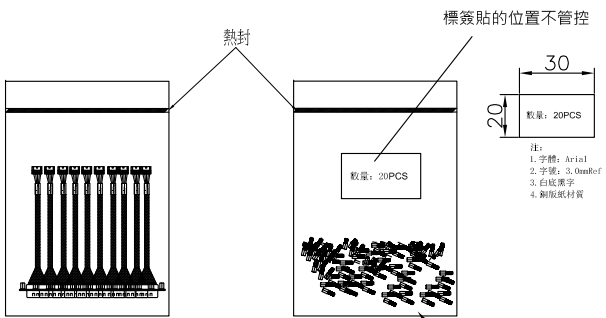

- 注:
1. 字體: Arial
 2. 字號: 2.0mmRef
 3. 白底黑字
 4. ||||| 為條碼, 能掃描出條碼上方的數字
 5. Code: 128碼
 6. yy代表年; ww代表周;
 7. 標籤中所有 "0" 為數字 "0"
 8. 銅版紙材質

NOTE:
1."*" 為重點尺寸
2.溫度-20-80度

- NOTE:
1. CABLE 10PCS/PE BAG
 2. 螺絲每20PCS另用 1PC PE BAG封裝

ELECTRONIC TEST CONDITION:
100% OPEN-SHORT & MISWIRE TEST.
CONDUCTIVE RESISTANCE:2Ω/MAX.
INSULATION RESISTANCE:20MΩ/MIN, AT DC300V.



ITEM		DESCRIPTION	Q'TY
⑦	LABEL	LABEL L40*W30mm 白底黑字 條碼標籤 銅版紙材質 MARK:"14011-03701100 ROHS	1PCS
⑥	醋酸膠布	醋酸膠布 W15*H10. 12mm 黑色 超薄ROHS:HF	AR
⑤	六角螺絲	六角螺絲 螺牙:#4-40UNC φ 4.75*L11.8mm 鋼合金鍍鎳(含鉛量低於1000PPM)(CJSW000002)	2PCS
④	熱熔膠條	透明熱熔膠條 OD=7.2mm L=300mm EVA 普通ROHS	AR
③	CONN.	CONN DB 9P/M 母線式 一體黑膠 漆金端子 前線後線型 后線六角螺母(外露3.0mm) 螺絲扭力5kg<扭>(D8-09MKVACACDE-HF) ROHS:HF	1PCS
②	HSG.	HSG DUPONT 2*5P PH=2.0mm 蓋裝2pin 黑色有線 左上角有"V"材質: Nylon 66<開蓋>(12003H00-2*5PA-K2-T-HF) TERMINAL DUPONT 紫端 PH=2.0mm 磷青銅鍍金(12003TOP-OA-J-NK)	1SET
①	WIRE	UL1007 #28(7/0.127) OD=1.2mm 300V ROHS	9PCS

RANGE	TOLERANCES
.X	±0.5
.XX	±0.3
.XXX	±0.1
X.	±1
XX.	±3
XXX.	±10
∴	∴

CUST. P/N: 華碩 (14011-03701100)
TITLE: CABLE COM M TO PH2.0 2XSP 300MM 10IN1
VSO P/N: N-831-010-00000006

UNITS mm DWG. NO.: DR4R05247 REV. X0

DCC ISSUED:

ENG:
DRAW: Shunhua
CHECK: Xiaogang

APPR:

THIS DRAWING IS CONTROLLED DOCUMENT FOR VSO LTD IT IS SUBJECT TO CHANGE AND THE CONTROLLING ENGINEERING ORGANIZATION SHOULD BE CONTACTED FOR THE LATEST REVISION

THIS INFORMATION IS CONFIDENTIAL AND IS DISCLOSED TO YOU ON CONDITION THAT NO FURTHER DISCLOSURE IS MADE BY YOU TO OTHER THAN VSO LTD PERSONNEL WITHOUT WRITTEN AUTHORIZATION FROM VSO LTD

由 AUTODESK 教育產品製造

DRAW ID
CD

4

3

2

1

REVISION				
REV.	DESCRIPTION	ECN NO.	DATE	Requirement Person
X0	NEW CREATION		21.07.14	shunhua

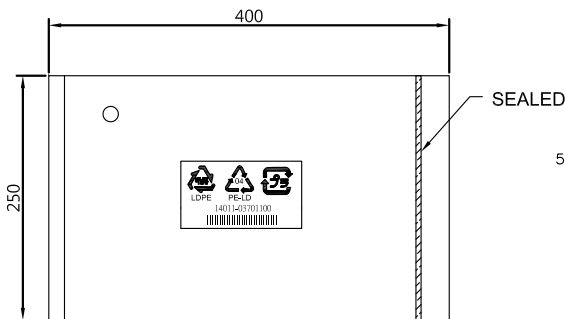

500PCS (50SET)/OUTER CARTON

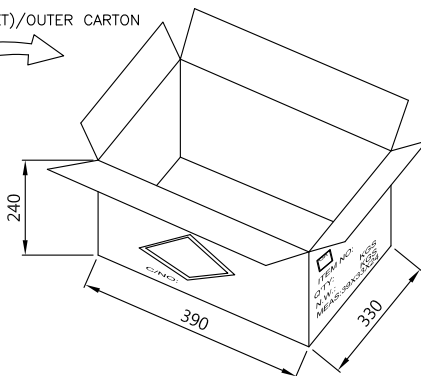

10PCS (1SET)/PE BAG

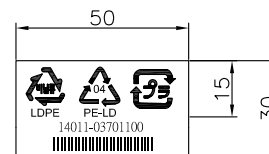
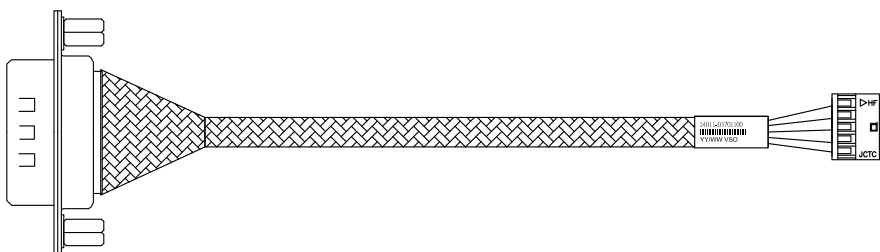

- 注:
1. 字體: Arial
 2. 字號: 2.5mm
 3. 白底黑字
 4. 材質銅版紙
 5. ||||| 為條碼, 能掃描出條碼上方的文字
 6. 此標籤為PE袋標籤, 只可機打不可手寫, 要貼在PE袋的中央.



- NOTE:
1. UL 標籤為橙底黑字
 2. UL 標籤貼于箱子側面左邊

DCC ISSUED:

RANGE	TOLERANCES
.X	±0.5
.XX	±0.3
.XXX	±0.1
X.	±1
XX.	±3
XXX.	±10
∘	∘
⊙	⊙

RoHS
COMPLIANT



CUST. P/N: 華碩 (14011-03701100)

TITLE: CABLE COM M TO PH2.0 2X5P 300MM 10IN1

VSO P/N: N-831-010-00000006

UNITS mm DWG. NO. : DR4R05247

REV. X0

ENG:

DRAW: Shunhua

CHECK: Xiaogang

APPR:

4

3

2

1

THIS DRAWING IS CONTROLLED DOCUMENT FOR VSO LTD IT IS SUBJECT TO CHANGE AND THE CONTROLLING ENGINEERING ORGANIZATION SHOULD BE CONTACTED FOR THE LATEST REVISION

THIS INFORMATION IS CONFIDENTIAL AND IS DISCLOSED TO YOU ON CONDITION THAT NO FURTHER DISCLOSURE IS MADE BY YOU TO OTHER THAN VSO LTD PERSONNEL WITHOUT WRITTEN AUTHORIZATION FROM VSO LTD

由 AUTODESK 教育產品製造

DRAW ID
CD

4

3

2

1

REVISION				
REV.	DESCRIPTION	ECN NO.	DATE	Requirement Person
X0	NEW CREATION		21.07.14	shunhua

105		140	150
95			
5			
5			
ASUSTEK	华硕电脑有限公司		
廠商	VSO		
廠商料號	N-831-010-00000006 		
華碩料號	14011-03701100 		
品名	CABLE COM M TO PH2.0 2X5P 300MM 10IN1		
規格	VSO/N-831-010-00000006		
數量	500 		
D/C	yy/mm 		
LOT NO:			
原產地:	China 		
淨重	fff KG		
制造日期:	yyyy/mm/dd		
Carton NO:	第幾箱/總箱數		
交貨日期	yyyy/mm/dd		

注:

1. 字體: Arial
2. 字號: 4mm
3. 白底黑字
4. 150*105為標籤總大小; 140*95為印刷區域
5. |||||為條碼, 能掃描出條碼上方的文字
6. y代表年; m代表月; d代表日期; f代表實際裝箱重量
7. 此標籤為外箱標籤, 只可機打不可手寫
且貼外箱側面的右上角。
8. 交貨日期與 Carton NO 欄要貼上出貨日期標籤
及箱號標籤。
9. 右上角要貼上月份標籤。

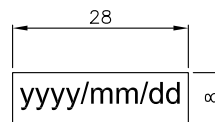

注:

1. 字體: Arial
2. 字號: 4mm
3. 白底黑字
4. y代表年; m代表月; d代表日期
5. 此標籤為出貨日期標籤,
只可機打不可手寫
且貼于外箱標籤的交貨日期欄。

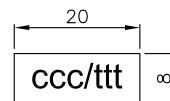

注:

1. 字體: Arial
2. 字號: 4mm
3. 白底黑字
4. cc代表第幾箱; tt代總箱數。
5. 此標籤為箱號標籤,
只可機打不可手寫
且貼于外箱標籤的 Carton NO 欄。

注:

1. 此為月份標籤。
2. 此標籤的顏色管控: 1、5和9月為藍色; 2、6和10月為綠色;
4、8和12月為黃色; 3、7和11月不用貼此標籤。
3. 標籤大小為OD:10mm.
4. 此標籤貼于外箱標籤的右上角。

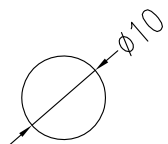

THIS DRAWING IS CONTROLLED DOCUMENT FOR VSO LTD IT IS SUBJECT TO CHANGE AND THE CONTROLLING ENGINEERING ORGANIZATION SHOULD BE CONTACTED FOR THE LATEST REVISION

THIS INFORMATION IS CONFIDENTIAL AND IS DISCLOSED TO YOU ON CONDITION THAT NO FURTHER DISCLOSURE IS MADE BY YOU TO OTHER THAN VSO LTD PERSONNEL WITHOUT WRITTEN AUTHORIZATION FROM VSO LTD

由 AUTODESK 教育產品製造

DCC ISSUED:

<table border="1"> <thead> <tr> <th>RANGE</th> <th>TOLERANCES</th> </tr> </thead> <tbody> <tr><td>.X</td><td>±0.5</td></tr> <tr><td>.XX</td><td>±0.3</td></tr> <tr><td>.XXX</td><td>±0.1</td></tr> <tr><td>X.</td><td>±1</td></tr> <tr><td>XX.</td><td>±3</td></tr> <tr><td>XXX.</td><td>±10</td></tr> <tr><td>∅</td><td>∅</td></tr> </tbody> </table>	RANGE	TOLERANCES	.X	±0.5	.XX	±0.3	.XXX	±0.1	X.	±1	XX.	±3	XXX.	±10	∅	∅	<table border="1"> <tr> <td>RoHS COMPLIANT</td> <td rowspan="2"> </td> </tr> <tr> <td>CUST. P/N: 華碩 (14011-03701100)</td> </tr> </table>	RoHS COMPLIANT		CUST. P/N: 華碩 (14011-03701100)	ENG:
	RANGE	TOLERANCES																			
.X	±0.5																				
.XX	±0.3																				
.XXX	±0.1																				
X.	±1																				
XX.	±3																				
XXX.	±10																				
∅	∅																				
RoHS COMPLIANT																					
CUST. P/N: 華碩 (14011-03701100)																					
	TITLE: CABLE COM M TO PH2.0 2X5P 300MM 10IN1	DRAW: Shunhua																			
	VSO P/N: N-831-010-00000006	CHECK: Xiaogang																			
	UNITS mm	DWG. NO.: DR4R05247	REV. X0																		
		APPR:																			

4

3

2

1