

BET-0600

60–65 Watt

- ✓ Desktop adapter for industrial applications
- ✓ Only with 105°C high quality capacitors
- ✓ Very high reliability (MTBF)
- ✓ Energy efficiency level VI and CoC Tier2 compliant
- ✓ Certified according to EN/IEC/UL 62368-1 (Ed. 2)
- ✓ High efficiency
- ✓ Low standby consumption <0.15 W
- ✓ Wide temperature range up to +60 °C
- ✓ International approvals



NEW







Desktop adapter

Technical data

Input voltage	90...264 V AC
Input frequency	50...60 Hz
Input current	1.4 A max.
Inrush current	70 A max (230 VAC, 25 °C)
Efficiency	App. 90%
Idle consumption	<0.15 W
Hold-up time	>10 ms (115 VAC)
Protection	Short circuit protection: Switch off with auto recovery Overvoltage protection: max. 150 % of nominal voltage Overload protection: max. 180 % of nominal current, switch off with auto recovery
Insulation voltage	Input / Output: 4242 VDC, Input / FG: 3000 VAC
Line regulation	±3%
Load regulation	±≤4 %
Leakage current	<0.5 mA earth leakage current (264 VAC)
Safety / EMC	CE, designed acc. to CCC, certified acc. to EN/IEC/UL 62368-1 (Ed.2)
Temperature	Operating: -20...+60 °C / Storage: -20...+85 °C
Derating	In the range of +40...+60 °C, 2% / °C
Max. operation altitude	3100 m
MTBF	>992000 h according to Telcordia SR-332 at +40 °C
Humidity	Operating: 10...85 % RH, non-condensing / Storage: 10...90 % RH, non-condensing
Dimensions (WxDxH)	53 x 115 x 38 mm ±0.5 mm
Weight (net)	0.3 kg

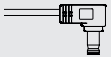
Product specific data

Energy efficiency level	Meets DoE / CEC / GEMS / NRCan level VI, ErP level V and CoC Tier2
Earth conductor	The -Vout (secondary GND) is connected to PE as <u>functional earth</u> . If your application needs a safety earth an extra direct PE connection to earth must be implemented!

Article No.	DC plug type	Output voltage	Output current min	Output current Rated load	Ripple & Noise	Efficiency (typ.)
BET-0612		+12 V	0 A	5.0 A	<120 mV _{pp}	App. 90 %
BET-0612-B4 ø5.5 x ø2.5 x 12 mm		+12 V	0 A	5.0 A	<120 mV _{pp}	App. 90 %
BET-0612-B5		+12 V	0 A	5.0 A	<120 mV _{pp}	App. 90 %
BET-0619		+19 V	0 A	3.4 A	<190 mV _{pp}	App. 90 %
BET-0624		+24 V	0 A	2.7 A	<240 mV _{pp}	App. 90 %

Ripple and Noise was measured at +21 °C ambient temperature by a 20 MHz bandwidth limited oscilloscope with connected 0.1 µF and 10 µF capacitors at the output and can deviate while starting when ambient temperature drops below 0 °C. Output voltage was adjusted to ±2 % at 60 % load. The final assembly has to comply with the valid EMC and safety standards.

Optional Accessories

▷▷▷ For detailed information please visit our website www.bicker.de and refer to the article number.

KP-01 | Cling pad

Cling pad for fast and easy attachment of desktop adapters, 113 x 45 mm, self-adhesive



X1-132 | Power cord

With IEC-60320-C13 connector, length 1800 mm

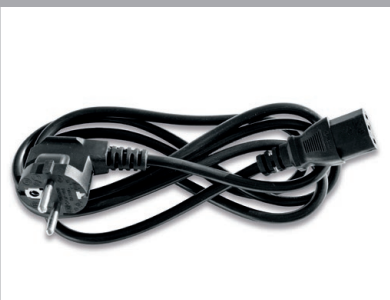

PSZ-1008 | Female adapter

DC jack on screw terminal, DC jack: 2.5 x 5.5 mm, AWG 26-12, Nominal current 5A max.



CB-TRG-EXT | DC extension cable

Extension cable for desktop adapters with DC plug and jack



Efficiency curves

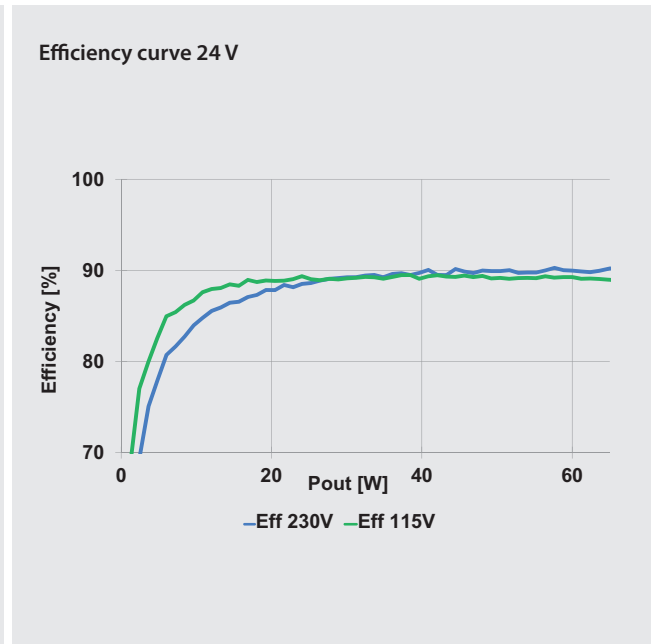
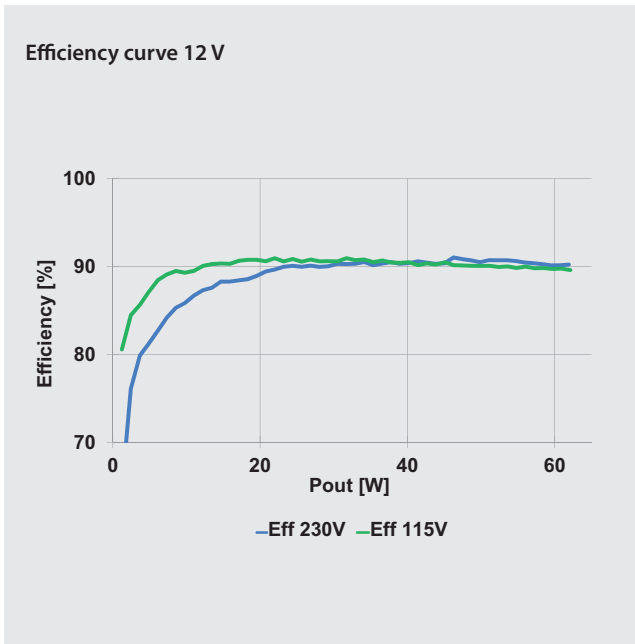

Desktop adapter

Derating

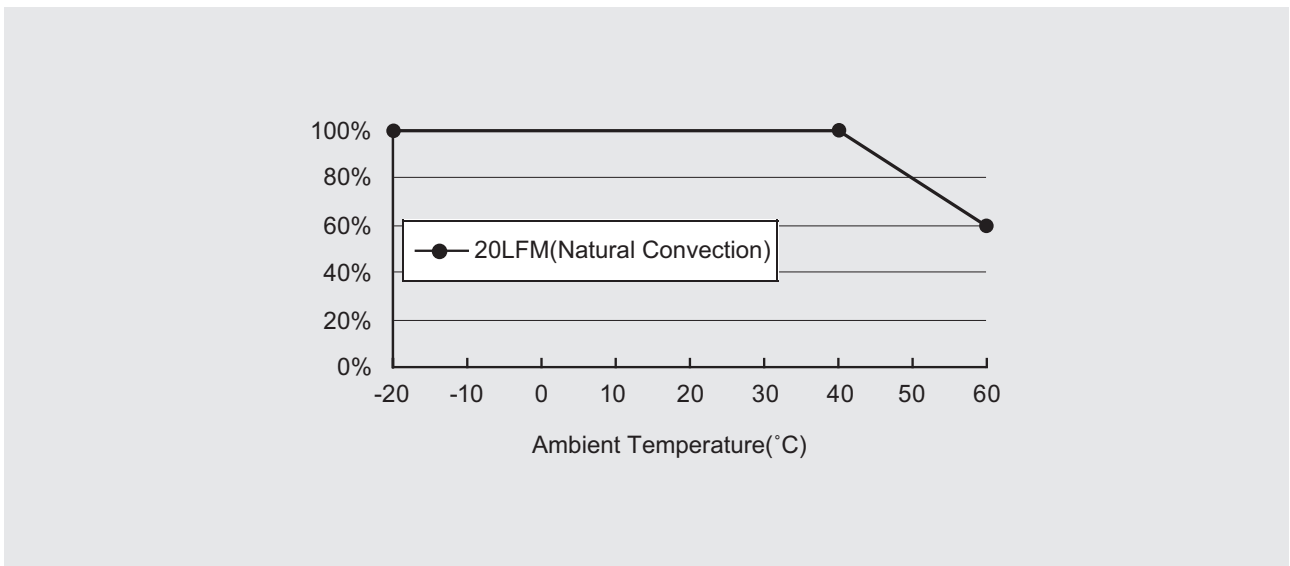

Drawing BET-0600

BET-0612: 16AWG
 BET-0619: 18AWG
 BET-0624: 18AWG

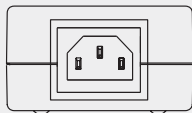
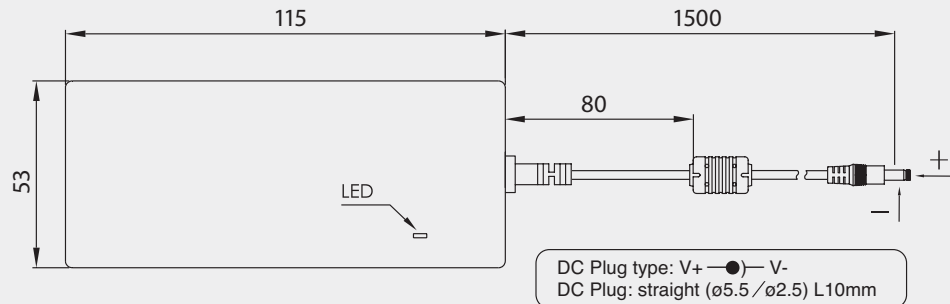

BET-0612-B5: 16AWG

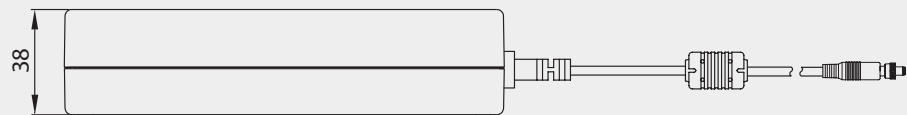
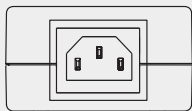
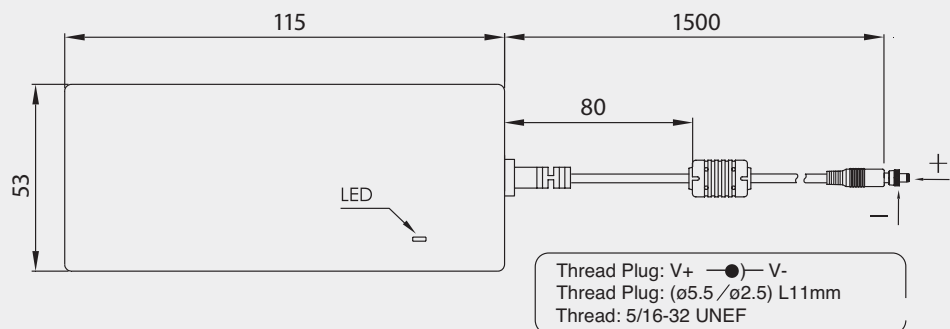

Special design

We are glad to assemble for you special requests such as screwable DC plugs (BET-0612-B5).

Contact us!



Tolerance Chassis ± 0.5 mm
 Tolerance Cable ± 50 mm